



BERAT CIVATA

İkitelli OSB. Bağcılar Güngören San. Sit. Büyük Çarşı Grubu No:26

İkitelli BAŞAKŞEHİR/İSTANBUL

Tel: 0212 671 57 07 Gsm: 0546 903 72 36

www.beratcivata.com www.civatasomun.net info@beratcivata.com

BRT 1123

**Konik Kapaklar/Tapalar
Kırmızı AYPE**

ISO A ve ISO B serisi tapaya uygun erkek fitting
Hortuma bağlı kalacak şekilde tasarlanmıştır
Toz, nem ve aşınmaya karşı Mükemmel Koruma
Isı -40°C / 135°C
Kapak veya tapa olarak kullanım
Kolay montaj ve sökme
Depolama ve taşıma esnasında hasar, kir,
nem ve korozyona karşı mükemmel koruma sağlar

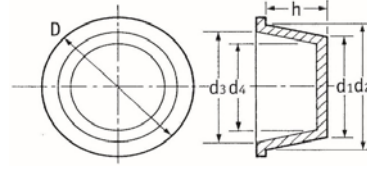

Sayfa - 1

Kod	d1	d2	d3	d4	H	h	Uyan Dişler	
10836	2,90	4,60	3,00	1,30	7,90	9,50	-	-
10991	4,40	6,10	4,50	2,80	9,50	9,50	M4	1/4" UNF
50222	4,70	8,50	5,70	2,50	11,70	22,50	-	-
12419	5,60	7,00	5,40	4,00	10,50	8,40	-	-
10727	6,20	7,60	5,90	5,00	11,10	9,50	M6	M8, 5/16" UNF
10549	7,70	9,10	7,70	6,30	12,70	9,50	-	3/8" UNF
12482	7,70	9,30	7,00	5,50	12,70	8,00	1/4" UNF	-
10289	8,40	10,00	8,20	6,90	13,50	9,50	M8	M10
12562	8,60	10,30	8,20	7,00	13,70	9,80	-	-
12483	9,00	10,70	8,80	7,50	13,90	11,50	-	-
10325	9,40	10,80	9,30	7,70	14,00	8,50	-	-
10750	10,00	11,80	10,00	8,50	15,00	9,50	3/8" UNF	M12
12420	10,60	12,20	10,00	8,60	15,60	9,80	-	-
10114	10,90	12,30	10,70	9,10	15,90	9,30	1/8" BSP	1/4" BSP, 1/2" UNF
12421	11,20	14,00	12,10	9,20	17,50	18,50	-	-
10421	11,30	13,20	11,60	9,80	17,00	11,00	-	-
12422	11,30	12,90	10,90	9,40	16,30	8,50	-	-
10174	11,50	13,00	11,50	10,00	16,70	9,50	-	M14 x 1.5
12901	12,00	14,80	12,00	10,50	17,50	11,00	-	-
10237	12,10	13,90	12,30	10,60	17,50	11,00	M12	9/16" UNF
12563	12,50	14,00	12,00	10,50	17,50	8,90	7/16" UNF	-
15137	12,80	15,10	13,20	10,70	18,50	23,10	-	-
10438	13,60	15,30	13,70	12,10	19,00	11,20	1/4" BSP, 1/2" UNF	M16
10342	14,20	16,00	14,40	12,70	19,00	12,10	M14	3/8" BSP
10424	14,70	17,00	15,40	13,20	20,60	12,70	-	M18 x 1.5
12481	14,90	16,40	14,50	13,50	21,00	11,50	-	-
12423	15,50	17,10	15,00	13,40	20,60	8,50	-	-
12564	16,10	17,60	15,50	14,50	21,00	8,50	-	-
11139	16,40	18,30	16,90	14,30	22,20	12,30	M16, 5/8" UNF	3/4" UNF
12196	16,60	18,50	16,50	14,50	21,90	13,00	-	-
110197	17,10	19,40	17,80	15,50	22,00	13,00	3/8" BSP	M20 x 1.5
12197	17,20	20,20	18,00	15,50	24,20	18,00	-	-
110198	17,50	20,10	18,50	15,90	24,00	14,50	M18 x 1.5, M18 x 2	1/2" BSP
11088	17,70	19,60	17,30	15,20	22,20	12,70	3/8" BSP	M20
10394	17,80	20,00	18,30	16,40	23,80	13,40	M18	1/2" BSP
12424	18,30	21,40	19,30	16,40	25,40	17,50	-	-
10208	18,50	20,90	19,30	17,10	24,60	14,30	3/4" UNF	M22 x 1.5
10728	19,00	21,50	19,70	17,60	25,80	14,30	-	M22 x 1.5, 7/8" UNF
12925	19,40	22,50	21,30	18,00	26,50	19,00	-	-
12425	20,50	23,20	21,20	18,50	27,20	17,50	-	-
52071	21,20	23,20	21,70	19,30	27,30	12,30	-	M24
10676	21,30	23,20	21,50	19,20	27,00	15,90	M20 x 2.5, 1/2" BSP	5/8" BSP
10376	22,00	25,00	23,00	20,50	28,50	15,90	M22	1" UNF
110200	22,00	24,80	23,20	20,40	29,00	17,00	M22 x 1.5	-
12565	22,50	25,50	23,30	20,00	28,90	17,80	7/8" UNF	-
12426	22,70	24,90	22,70	20,80	27,00	12,00	-	-
10136	23,40	26,40	24,40	21,40	29,30	17,50	M24	3/4" BSP, M27, M26
12427	24,00	26,90	25,00	21,90	31,00	18,00	-	-
12567	24,60	29,50	27,50	22,50	34,00	27,50	-	-
10732	24,70	27,70	26,10	23,20	32,00	19,00	M25, 1" UNF	M28, M30, 11/8" UNF
110201	25,20	29,20	27,70	23,70	33,00	19,00	-	-
12999	26,60	29,70	28,30	24,60	31,60	26,30	3/4" BSP	7/8" BSP



BERAT CIVATA

İkitelli OSB. Bağcılar Güngören San. Sit. Büyük Çarşı Grubu No:26

İkitelli BAŞAKŞEHİR/İSTANBUL

Tel: 0212 671 57 07 Gsm: 0546 903 72 36

www.beratcivata.com www.civatasomun.net info@beratcivata.com

BRT 1123

Konik Kapaklar/Tapalar
Kırmızı AYPE

ISO A ve ISO B serisi tapaya uygun erkek fitting
Hortuma bağlı kalacak şekilde tasarlanmıştır
Toz, nem ve aşınmaya karşı Mükemmel Koruma
Isı -40°C / 135°C

Kapak veya tapa olarak kullanım

Kolay montaj ve sökme

Depolama ve taşıma esnasında hasar, kir,
nem ve korozyona karşı mükemmel koruma sağlar

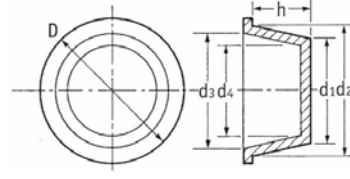

Sayfa - 2

Kod	d1	d2	d3	d4	H	h	Uyan Dişler	
10250	28,00	30,90	29,00	26,50	35,30	19,00	M27, M28	M30 x 1.5
11173	29,20	31,20	30,30	28,00	34,70	12,70	M22 x 2	M33, 1" BSP
10272	30,00	32,60	30,70	27,50	36,70	15,20	M30	M33, 1" BSP
12428	30,50	33,30	31,10	28,40	37,00	14,50	7/8" BSP	15/16" x 12 UNF
10154	31,10	34,40	32,80	29,80	38,10	19,00	M33, M32, 1 1/4" UNF	M36
12568	31,10	34,30	32,00	29,30	38,10	17,50	-	13/8" UNF, M36
12569	31,60	36,30	34,00	29,80	40,20	24,10	1 5/16" BSP	1 5/16" BSP
10181	33,30	37,20	35,60	31,70	41,60	22,20	1" BSP	M38, 11/8" BSP
11167	33,30	34,40	32,80	31,40	38,10	9,50	-	-
10838	33,90	37,30	35,80	32,00	42,20	12,30	13/8" UNF	1 1/8" BSP
12480	33,90	38,30	36,50	31,90	42,30	24,50	-	-
12198	34,90	36,40	35,20	33,10	42,70	8,20	-	-
12570	35,90	40,20	37,50	33,20	44,10	24,50	-	-
15138	36,30	38,30	37,00	34,60	42,30	12,00	-	-
10491	36,90	40,60	39,00	35,00	44,00	22,50	M38	11/4" BSP
11115	38,60	40,60	39,00	37,10	44,50	12,70	11/2" UNF	-
10485	39,60	42,70	41,10	38,20	47,60	18,50	M39, M40	M42
12429	40,80	44,70	41,80	37,70	49,00	24,00	-	-
10252	41,40	44,80	43,00	39,70	49,20	19,00	11/4" BSP	M45 x 2
11172	42,50	44,80	43,00	40,70	50,70	12,60	-	-
15139	43,40	48,50	47,00	42,00	53,30	24,50	-	-
10812	44,10	46,70	45,70	42,80	49,80	18,40	-	-
110204	44,40	47,70	46,10	42,80	51,00	19,00	M45 x 1.5/2/3	M48 x 2, 17/8" JIC/UNF, 11/2" BSP
10168	45,20	49,00	47,00	43,70	53,40	24,50	13/8" BSP	M48, 11/2" BSP
10439	45,90	46,30	45,00	44,30	50,80	9,50	-	M48
15136	46,00	50,00	48,00	44,30	54,00	24,80	-	-
12430	47,20	51,90	48,70	44,50	55,80	24,00	-	-
11131	47,50	50,30	49,00	45,20	54,00	25,00	-	-
10820	48,00	52,70	50,70	46,30	57,10	25,40	-	-
10086	48,60	51,20	48,90	46,70	55,50	18,70	M48, 1 1/2" BSP	M52
12746	49,80	54,00	52,00	47,50	58,00	24,30	-	-
10624	51,10	54,40	52,00	47,70	57,00	25,00	-	-
10935	51,50	54,10	52,00	49,60	58,30	18,50	-	-
11047	53,50	57,00	55,30	51,20	62,40	25,10	13/4" BSP	M56, M55
12431	54,00	58,40	55,00	50,80	62,40	24,50	-	-
10616	55,00	61,00	59,00	52,20	65,00	25,00	-	-
11168	55,40	58,80	57,20	53,70	65,00	25,10	M58	2" BSP
11169	57,50	57,60	56,10	55,20	63,60	12,80	-	-
11100	59,30	67,30	64,10	56,70	70,30	31,70	-	-
10249	59,60	62,60	61,00	57,00	66,70	24,60	2" BSP	-
11075	62,00	66,40	64,30	59,00	71,00	28,00	-	-
10292	63,30	69,80	67,80	61,50	73,00	25,40	-	-
10399	64,50	67,30	65,60	62,10	70,60	15,80	-	-
11064	68,10	70,90	69,30	66,30	74,60	19,00	-	-
10302	70,00	75,80	74,00	68,10	79,40	25,40	-	M76, M75, 21/2" BSP
10550	74,00	76,80	73,40	70,00	80,00	24,40	-	-
10617	74,00	77,00	73,90	71,50	82,50	18,70	-	-
11023	76,80	82,20	80,80	74,80	85,70	25,40	-	-
11170	77,10	80,70	78,20	74,80	85,70	19,00	21/2" BSP	-
11037	80,00	86,10	82,00	77,50	89,80	25,10	-	-
10353	84,20	90,80	88,30	82,70	94,50	28,00	3" BSP	-
11171	85,30	88,00	85,50	82,90	92,00	19,00	-	-



BERAT CIVATA

İkitelli OSB. Bağcılar Güngören San. Sit. Büyük Çarşı Grubu No:26

İkitelli BAŞAKŞEHİR/İSTANBUL

Tel: 0212 671 57 07 Gsm: 0546 903 72 36

www.beratcivata.com www.civatasomun.net info@beratcivata.com

BRT 1123

**Konik Kapaklar/Tapalar
Kırmızı AYPE**

ISO A ve ISO B serisi tapaya uygun erkek fitting
Hortuma bağlı kalacak şekilde tasarlanmıştır
Toz, nem ve aşınmaya karşı Mükemmel Koruma
Isı -40°C / 135°C

Kapak veya tapa olarak kullanım
Kolay montaj ve sökme

Depolama ve taşıma esnasında hasar, kir,
nem ve korozyona karşı mükemmel koruma sağlar

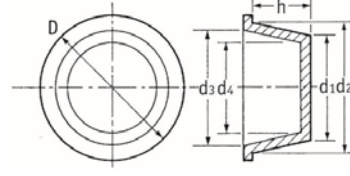

Sayfa - 3

Kod	d1	d2	d3	d4	H	h	Uyan Dişler
12572	87,50	93,60	90,50	84,30	96,70	34,30	-
10304	88,10	93,30	89,90	85,10	96,50	28,60	-
10253	92,10	97,00	94,00	88,30	100,00	32,00	-
10697	93,50	100,30	97,80	89,90	107,50	26,50	-
12573	94,50	100,60	97,00	91,00	103,60	34,50	-
462569	96,50	102,00	101,00	94,00	110,00	31,00	-
12199	98,00	102,00	98,50	94,80	107,20	24,70	-
10551	98,20	103,30	99,00	95,00	106,00	28,80	-
110785	101,00	107,00	103,00	98,00	109,00	28,60	-
10688	101,90	107,50	103,00	98,00	109,00	28,60	-
10771	106,70	111,70	107,40	107,40	113,30	28,60	-
10455	108,00	114,10	111,60	106,40	118,50	35,20	-
462570	109,00	113,00	111,00	106,00	123,00	27,00	-
10837	110,00	115,00	109,00	105,00	118,50	28,00	-
12574	111,50	117,60	115,00	107,50	122,00	35,00	-
10133	112,10	114,30	109,80	107,50	116,80	28,60	-
10355	124,00	128,00	125,00	121,00	134,00	23,00	-
12575	129,00	135,10	132,00	124,00	139,50	36,50	-
462571	133,00	137,00	134,20	130,20	143,00	22,00	-
12576	139,50	145,60	140,00	135,00	150,00	36,50	-
10356	146,80	151,00	148,60	142,80	159,50	33,00	-
39649	153,70	161,50	160,00	152,00	178,90	29,60	-
12577	156,00	162,30	158,80	151,80	167,30	36,70	-
39196	202,90	203,80	198,80	198,00	218,70	32,70	-
462572	203,50	208,50	205,90	200,90	216,00	24,00	-
39666	216,00	223,60	223,00	213,00	241,50	29,10	-
39195	252,20	257,80	247,80	247,20	272,50	33,80	-
39149	304,20	308,40	299,40	299,20	322,60	33,90	-



BERAT CIVATA

İkitelli OSB. Bağcılar Güngören San. Sit. Büyük Çarşı Grubu No:26

İkitelli BAŞAKŞEHİR/İSTANBUL

Tel: 0212 671 57 07 Gsm: 0546 903 72 36

www.beratcivata.com www.civatasomun.net info@beratcivata.com

BRT 1124

Daha iyi koruma ve kolay söküm

Konik Kapaklar/Tapalar -
Flanşlı Serisi
Kırmızı LDPE

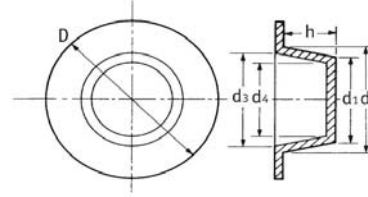

Kod	d1	d2	d3	d4	D	h	Uyan Dışlar	
12432	7,60	9,30	7,70	6,30	18,40	9,50	-	-
12433	10,70	12,30	10,70	9,10	22,00	9,50	1/8" BSP	1/4" BSP, 1/2" UNF
10420	11,30	13,20	11,60	9,80	29,00	11,00	-	-
110831	11,40	12,40	10,50	9,50	15,00	7,00	-	-
12434	13,50	15,50	13,20	11,40	30,00	9,50	-	-
18349	13,60	15,40	13,80	12,20	22,20	11,10	1/4" BSP, 1/2" UNF	M16, 5/8" UNF
18351	14,70	16,90	15,40	13,20	25,40	12,70	-	M18
12435	17,50	20,00	18,50	16,10	34,90	14,30	M18	1/2" BSP
18356	19,10	21,50	19,90	17,60	38,10	14,30	-	-
12436	21,90	25,00	22,00	18,90	48,00	17,50	-	-
12134	22,50	25,30	23,50	20,80	55,40	17,30	-	-
18357	24,70	27,70	26,10	23,20	38,10	19,10	-	M27, M30
12437	30,40	33,60	30,70	27,80	47,30	15,20	M30	M33, M32, 1" BSP
18360	31,10	34,40	32,80	29,80	47,60	19,10	M33, M32, 11/4" UNF	M35
12438	33,30	37,20	35,60	32,00	50,80	22,20	M35, 1" BSP	M36, M38, 11/8" BSP 11/2" UNF
12439	36,90	40,60	39,00	35,00	54,20	22,50	M38, 11/8" BSP	M39, M40, 11/4" BSP
18362	41,40	44,80	43,00	39,70	57,20	19,00	M42, 11/4" BSP	M45
12441	47,20	51,90	48,70	44,50	72,00	24,00	-	-
18366	48,30	52,70	50,70	46,30	63,50	25,40	M48, 13/4" BSP	M52
18368	51,50	54,10	52,00	49,60	66,70	18,50	-	-
18373	55,00	61,00	59,00	52,50	76,70	25,00	-	-
18374	62,00	66,40	64,30	59,00	83,00	28,00	-	-

BRT 1176

Yandan Çekme Kulaklı Konik
Tapa
Malzeme Doğal Termoplastik
Kauçuk

Yumuşak ve esnek malzeme sıkı
geçmeye izin verir
Yandaki çekme kulağı sökümün
kolaylaşmasını sağlar
Çeşitli kullanım alanlarına uygundur

Kod	d1	d2	D	H	W	L
494297	5.0	7.0	11.0	9.5	7.0	15.0
494298	6.0	8.0	12.0	9.5	7.0	15.0
494299	7.0	9.5	13.5	9.5	7.0	15.0
494300	8.0	10.0	14.0	9.5	8.0	15.0
494301	9.5	11.5	15.5	9.5	8.0	15.0
494302	10.5	12.5	16.5	9.5	8.0	15.0
494303	11.5	13.5	17.5	9.5	8.0	15.0
494304	12.5	14.5	18.5	10.0	8.0	15.0
494305	13.5	15.5	19.5	10.0	10.0	15.0
494306	14.2	16.2	20.2	10.0	10.0	15.0
494307	14.5	17.0	21.0	10.0	10.0	15.0
494308	15.5	18.0	22.0	10.0	10.0	15.0
494309	17.5	19.5	23.5	10.0	10.0	15.0
494310	19.0	21.5	25.5	11.0	10.0	15.0
494311	21.0	23.5	27.5	11.0	10.0	15.0
494312	22.5	25.5	29.5	12.0	12.0	15.0
494313	25.0	28.0	32.0	12.0	12.0	15.0
494314	29.0	31.5	35.5	12.0	12.0	15.0

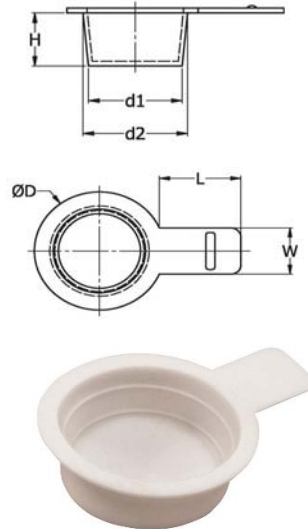



BERAT CIVATA

İkitelli OSB. Bağcılar Güngören San. Sit. Büyük Çarşı Grubu No:26

İkitelli BAŞAKŞEHİR/İSTANBUL

Tel: 0212 671 57 07 Gsm: 0546 903 72 36

www.beratcivata.com www.civatasomun.net info@beratcivata.com

BRT 1234

Konik Kapaklar/Tapalar
Mavi Seri
Mavi LDPE

Kapak veya tapa olarak kullanım
Kolay montaj ve söküm
Depolama ve taşıma esnasında hasar, kir,
nem ve korozyona karşı mükemmel koruma sağlar

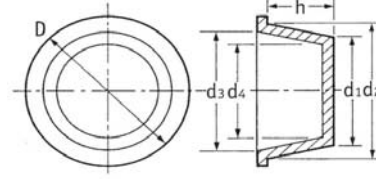

Sayfa - 1

Kod	d1	d2	d3	d4	D	h
1	2,90	4,60	3,00	1,30	7,90	10,30
1S	3,50	4,60	3,00	1,30	7,90	6,40
2	4,50	6,10	4,50	2,80	9,50	9,50
3	5,30	6,80	4,90	3,20	9,50	9,50
5	6,10	7,70	6,10	4,50	11,90	9,50
6	6,70	8,50	7,00	5,20	11,90	9,50
7	7,60	9,30	7,70	5,90	13,50	9,50
7-S	8,40	9,30	7,70	6,80	12,70	5,60
8	8,40	10,10	8,40	7,00	14,30	9,50
9	9,10	10,90	9,30	7,60	15,10	9,50
10	9,90	11,70	10,10	8,30	15,90	9,50
11	10,70	12,30	10,70	9,00	15,10	9,50
12	11,40	13,00	11,40	9,80	15,90	10,30
13-SP	12,10	13,80	12,20	10,40	18,30	7,90
13-W	12,10	13,90	12,30	10,40	22,20	12,70
13	12,50	13,90	12,30	10,40	18,30	12,70
14	12,70	14,40	12,80	11,10	19,10	11,10
16	13,50	15,80	14,10	11,90	19,10	11,80
17	14,00	16,10	14,40	12,30	19,80	12,70
18	15,00	17,20	15,40	13,20	22,20	13,50
20	15,50	17,70	16,10	13,90	21,40	12,70
21	16,30	18,50	16,90	14,60	22,20	12,70
22	17,20	19,20	17,50	15,60	22,20	15,90
23	17,50	19,90	18,40	15,90	23,80	15,90
26	18,40	21,00	19,30	16,80	25,40	12,70
26-L	18,40	21,00	19,30	16,80	24,60	15,00
27	19,10	21,50	19,70	17,40	26,20	15,90
28	20,40	23,10	21,50	18,40	27,80	19,10
29	20,80	23,70	21,60	19,20	28,60	14,60
30	21,70	24,70	23,00	19,50	28,60	19,10
31	22,10	24,80	23,40	20,40	28,60	15,90
35	22,70	26,40	24,80	21,10	29,40	19,10
40	24,50	27,70	26,00	22,90	31,80	19,10
38	24,90	26,50	25,00	22,30	31,80	12,70
41	25,50	29,10	27,40	23,80	33,30	19,10
42	28,20	31,20	30,00	26,40	38,50	19,10
44	30,00	32,60	30,90	28,10	36,50	19,10
45	31,10	34,30	32,90	29,50	38,10	19,10
46	31,40	34,30	32,90	29,00	36,50	19,10
47	32,80	34,60	33,02	31,20	38,10	19,10
48	32,80	37,00	35,30	31,20	41,30	25,40
49	33,30	37,30	35,60	31,70	41,30	19,10
51	34,10	38,50	36,80	32,60	44,50	23,80
53	36,80	40,60	39,00	35,20	44,50	19,10
54	38,60	40,70	39,00	37,00	45,20	19,10
K-5	38,70	38,70	37,70	36,70	44,50	12,70
55	39,60	42,50	41,20	38,00	47,60	19,10
56	40,80	44,50	42,80	39,80	49,20	19,10
57	44,10	47,50	46,20	42,60	51,60	19,10
59	45,70	46,40	44,70	44,10	51,60	12,70
58	45,90	49,70	48,10	44,30	54,00	25,40
60	46,90	51,30	49,20	45,30	54,00	25,40
62	48,30	53,00	51,20	46,70	57,20	25,40
63	50,30	55,10	53,60	48,60	57,20	25,40



BERAT CIVATA

İkitelli OSB. Bağcılar Güngören San. Sit. Büyük Çarşı Grubu No:26

İkitelli BAŞAKŞEHİR/İSTANBUL

Tel: 0212 671 57 07 Gsm: 0546 903 72 36

www.beratcivata.com www.civatasomun.net info@beratcivata.com

BRT 1234

Konik Kapaklar/Tapalar
Mavi Seri
Mavi LDPE

Kapak veya tapa olarak kullanım

Kolay montaj ve söküm

Depolama ve taşıma esnasında hasar, kir,

nem ve korozyona karşı mükemmel koruma sağlar

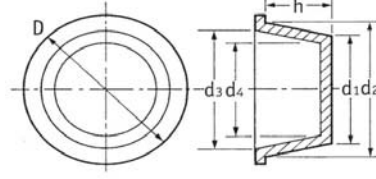

Sayfa - 2

Kod	d1	d2	d3	d4	D	h
65	51,20	54,50	52,90	49,70	58,70	19,10
66	52,40	57,20	55,30	50,80	61,90	26,20
70	54,10	61,60	60,20	51,90	63,50	25,40
67	54,80	59,80	58,10	52,90	66,70	25,40
68	56,50	57,90	56,40	54,60	63,50	12,70
71	58,40	63,10	61,00	56,80	66,70	25,40
75	58,70	67,30	65,70	57,00	69,90	25,40
73	60,80	66,20	64,50	59,20	66,70	25,40
74	61,70	67,20	65,50	61,50	69,90	19,10
76	62,40	69,90	68,20	60,80	73,00	25,40
77	65,00	68,30	66,70	63,50	73,00	19,10
78	67,20	71,30	69,20	65,50	76,20	12,70
81	69,10	76,20	74,90	66,70	79,40	25,40
82	72,40	75,70	74,20	70,70	82,60	19,10
85	75,70	82,40	80,40	73,70	85,70	25,40
83	76,10	80,20	78,70	74,00	85,70	12,70
86	78,50	85,50	83,40	76,30	88,90	25,40
88	82,20	90,80	88,80	80,20	100,00	25,40
87	84,30	87,60	85,60	82,30	92,10	12,70
89	88,00	91,40	89,20	86,50	98,40	22,40
90	93,40	96,50	94,70	91,60	101,60	19,10
91	96,50	99,70	97,70	94,40	104,80	17,50
92	99,50	103,40	101,10	96,80	111,10	19,80
93	102,40	106,40	104,40	100,30	114,30	19,10
94	107,10	112,90	111,30	105,00	123,80	25,40
95	110,90	117,00	114,30	109,00	127,00	25,40
1100	124,70	129,30	127,30	122,70	139,70	26,20
1110	126,80	132,10	129,50	125,00	143,00	26,20
101	138,90	142,80	140,70	136,90	155,70	25,40
39665	141,00	150,00	148,00	138,00	164,10	25,40
103	143,30	149,20	147,20	140,70	158,80	25,40
FPL-6	152,00	153,40	-	-	167,90	32,50
104	152,70	157,00	154,90	150,40	168,20	25,40
106	162,60	166,60	164,60	160,80	176,30	22,90
108	167,90	170,40	168,40	165,90	182,60	38,90
K-436	174,80	178,60	176,50	172,70	194,80	13,50
110	179,10	180,90	178,80	177,00	193,80	26,20
112	186,40	194,30	192,00	184,40	201,70	26,20
114	194,60	199,10	197,10	192,50	206,30	26,20
118	207,20	212,10	209,60	204,50	222,30	35,70
120	213,40	218,40	215,90	210,80	228,60	35,70
124	220,20	221,70	219,10	217,20	231,90	38,90
126	230,10	237,70	234,70	225,80	250,40	45,20
130	274,10	281,90	277,10	268,00	294,60	45,20
132	282,20	291,10	286,30	273,80	303,80	51,60
133	303,00	319,00	313,70	297,20	331,50	51,60
134	324,90	338,80	328,00	318,30	346,50	51,60
136	336,60	345,40	340,40	330,20	358,10	51,60



BERAT CIVATA

İkitelli OSB. Bağcılar Güngören San. Sit. Büyük Çarşı Grubu No:26

İkitelli BAŞAKŞEHİR/İSTANBUL

Tel: 0212 671 57 07 Gsm: 0546 903 72 36

www.beratcivata.com www.civatasomun.net info@beratcivata.com

BRT 1238

Konik Fanşlı Plastik Tapa
Mavi Seri
Malzeme Mavi AYPE

KOD	d1	d2	d3	d4	D	h
LF2A	4.4	6.1	4.5	2.8	14.3	11.8
LF-3	6.0	7.4	6.2	3.7	12.3	10.2
LF-6	9.3	10.6	9.0	7.6	18.8	10.2
LF-7	10.1	11.4	9.7	8.3	19.8	10.2
LF-10	12.2	13.9	12.5	10.4	22.1	11.7
LF-11X	14.4	16.0	14.7	12.7	24.1	12.5
LF-12X	15.5	17.5	16.1	13.9	26.2	13.4
LF-15X	18.4	20.6	19.4	16.8	29.0	15.0
LF-17	20.8	23.4	22.0	18.8	31.8	15.8
LF-19	24.1	25.9	24.3	22.2	34.1	18.2
LF-28	43.9	48.0	46.4	41.9	58.7	18.9

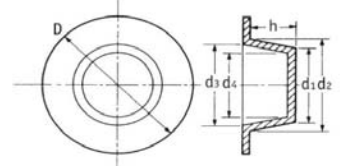

BRT 1237

Konik Geçme Tapa
Malzeme Mavi AYPE

KOD	d1	d2	d3	d4	D	h
EN-1	1"	26.2	27.7	30.5	34.1	16.7
EN-1/2	1/2"	15.9	17.5	19.9	23.0	12.7
EN-1/4	1/4"	9.0	10.7	12.3	15.5	7.1
EN-3/4	3/4"	20.6	22.1	24.8	27.8	15.9
EN-3/8	3/8"	12.7	14.0	16.3	19.5	12.7

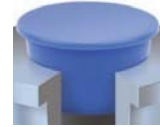
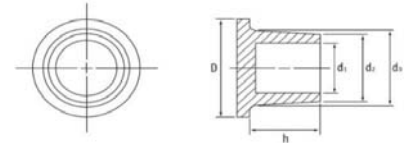

BRT 1297

Halka Tırnaklı Plastik
Konik Tapa
Malzeme Sarı AYPE

Tapa ya da kapak olarak
kullanılabilir
Uzun boyutlar için konik
profil
Güçlü halka tırnakla
parçayı kolay sökme
imkanı

KOD	d1	d2	H	D	L
498716	5.0	7.0	9.5	17.3	20.3
498717	6.0	8.0	9.5	18.2	21.1
498718	7.0	9.5	9.5	20.3	23.3
498719	8.0	10.0	9.5	20.3	23.2
498720	9.5	11.5	9.5	21.9	24.8
498721	10.5	12.5	9.5	22.6	26.5
498722	11.5	13.5	9.5	23.7	27.5
498723	12.5	14.5	10.0	24.5	28.4
498724	13.5	15.5	10.0	25.5	29.5
498725	14.2	16.2	10.0	26.3	30.3
498726	14.5	17.0	10.0	27.0	31.0
498727	15.5	18.0	10.0	28.3	32.0
498728	17.5	19.5	10.0	30.0	34.0
498729	18.0	20.0	10.0	30.0	34.0
498730	19.0	21.5	11.0	32.0	35.7
498731	21.0	24.2	11.0	34.7	38.7
498732	22.5	25.5	12.0	36.0	40.0
498733	25.0	28.0	12.0	38.5	42.2
498734	29.0	31.5	12.0	41.8	47.0
498735	29.5	32.0	12.0	42.5	47.6

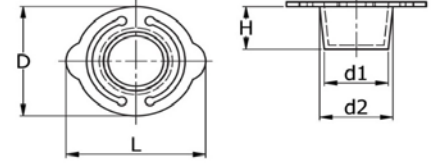



BERAT CIVATA

İkiteli OSB. Bağcılar Güngören San. Sit. Büyük Çarşı Grubu No:26

İkiteli BAŞAKŞEHİR/İSTANBUL

Tel: 0212 671 57 07 Gsm: 0546 903 72 36

www.beratcivata.com www.civatasomun.net info@beratcivata.com

BRT 1191

Ortadan Çekmeli Plastik Tapalar
Malzeme Turuncu ve Kırmızı AYPE

Kolay takma ve sökme için ortadan çekmeli tapa
Üretim, depolama ve taşıma esnasında hasar,
kir, nem ve korozyona karşı mükemmel koruma

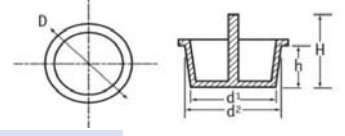

KOD	Metrik	UNF	BSP	d1	d2	D	h	H	Renk
110029	M8	5/16"	-	6.2	7.7	11.1	9.5	20.5	Kırmızı
110030	M10	7/16"	1/8"	8.4	10.0	13.5	9.5	20.5	Kırmızı
110031	-	3/8"	-	9.5	10.8	14.0	9.5	20.5	Kırmızı
110032	M12	1/2"	1/4"	10.9	12.3	15.9	9.5	20.3	Kırmızı
110033	M14	9/16"	-	11.7	13.7	17.2	11.0	22.0	Kırmızı
110034	M16	5/8"	3/8"	14.2	16.0	19.0	11.9	22.9	Kırmızı
110035	M20	3/4"	-	16.4	18.3	22.2	12.3	23.5	Kırmızı
110036	-	13/16"	1/2"	17.8	20.0	23.8	13.7	24.5	Kırmızı
110037	M24	7/8"	5/8"	21.3	23.2	27.0	15.9	26.9	Kırmızı
10418	-	1"	-	22.5	25.5	28.9	17.8	29.0	Kırmızı
110038	M28, M30	1 1/8"	-	24.7	27.7	32.0	19.0	30.0	Kırmızı
110039	M52	-	-	48.2	52.7	57.1	25.4	26.4	Kırmızı
110040	M58, M60	-	2"	55.0	61.0	65.0	25.0	26.0	Kırmızı
110041	M62	-	-	59.3	67.3	70.6	30.7	31.5	Kırmızı
110042	-	-	-	67.4	70.2	74.6	25.0	26.0	Kırmızı
CP-6	-	-	-	6.8	8.5	11.9	10.3	15.9	Turuncu
CP-9	-	-	-	9.2	10.9	15.1	9.5	19.1	Turuncu
CP-10	-	-	-	10.2	11.8	15.9	9.5	19.1	Turuncu
CP-12	-	-	-	11.4	13.0	16.7	10.3	14.3	Turuncu
CP-14	-	-	-	12.7	14.4	18.3	11.9	20.6	Turuncu
CP-18	-	-	-	14.7	17.0	20.6	13.5	19.1	Turuncu
CP-19	-	-	-	15.5	17.7	21.3	13.5	19.8	Turuncu
CP-24	-	-	-	18.5	21.0	25.4	15.0	21.3	Turuncu
CP-31	-	-	-	22.1	24.7	28.5	19.1	25.4	Turuncu
CP-37	-	-	-	24.6	27.7	31.8	19.8	26.2	Turuncu
CP-40	-	-	-	26.1	29.1	34.0	19.1	25.4	Turuncu
CP-42	-	-	-	27.8	31.0	35.8	19.8	25.4	Turuncu
CP-44	-	-	-	29.2	32.7	39.4	19.1	25.4	Turuncu
CP-47	-	-	-	32.8	33.2	38.1	19.8	25.4	Turuncu
CP-49	-	-	-	33.3	37.2	41.2	19.1	25.4	Turuncu
CP-51	-	-	-	34.1	38.8	44.5	22.4	25.4	Turuncu
CP-55	-	-	-	36.9	40.7	44.5	19.1	25.4	Turuncu
CP-56	-	-	-	41.0	44.1	48.4	18.3	28.6	Turuncu
CP-57	-	-	-	45.9	49.2	54.9	25.4	31.8	Turuncu



BRT 1233

Yandan Çekmeli Plastik Kulaklı Tapa
Malzeme Mavi AYPE

Kapak veya tapa olarak kullanım
Kolay söküm için yan çekme kulağı

Kod	d1	d2	D	h
P-7	7.6	9.3	13.5	9.5
P-8	8.4	10.1	14.3	9.5
P-11	10.7	12.3	15.1	9.5
P-16	13.5	15.8	19.1	12.7
P-17	14.0	16.1	19.8	12.7
P-23	17.5	19.9	23.8	15.9
P-26	20.4	23.2	26.9	16.5
P-31	22.1	24.8	28.6	15.9
P-33	23.2	26.4	29.4	18.3
P-40	24.5	27.7	31.8	19.8
P-41	25.3	29.1	33.3	19.8
P-42	28.2	31.2	38.5	19.1
P-44	29.6	32.4	35.7	19.1
P-53	36.8	40.6	44.5	19.1
P-55	39.6	40.6	47.6	19.1
P-57	41.5	44.5	49.3	19.1
P-59	45.7	46.4	51.6	12.7
P-61	45.2	49.5	53.9	25.4
P-63	46.8	50.8	53.9	25.4
P-65	48.2	52.7	57.2	25.4
P-68	56.7	57.4	63.5	12.7

